



**AIRCRAFT ACCIDENT AND INCIDENT  
INVESTIGATION AND PREVENTION BUREAU  
(AIB GHANA)**

---

**AIRCRAFT INCIDENT REPORT  
AIB/2021/09/03/INCID**

---

**REPORT ON THE BIRD STRIKE INCIDENT  
INVOLVING KLM FLIGHT KL 590 BOEING 777-300 ER  
AIRCRAFT WITH REGISTRATION PH-BVK ON 3<sup>RD</sup>  
SEPTEMBER, 2021 AT KOTOKA INTERNATIONAL  
AIRPORT, ACCRA, GHANA.**

---

This investigation was conducted by the Aircraft Accident and Incident Investigation and Prevention Bureau (AIB Ghana) in accordance with the International Civil Aviation Organisation (ICAO) Annex 13 and the Ghana Aircraft Accident and Incident Investigation and Prevention Bureau Act, 2020 (Act 1028).

The sole objective of this investigation is to prevent the occurrence of future incidents. It is not the purpose of this investigation to apportion blame or liability. Furthermore, this report should not be used to assign blame, fault or to determine liability.

No part of this report can be copied or reproduced for any purpose without permission from the Aircraft Accident and Incident Investigation and Prevention Bureau (AIB Ghana) except for general safety references.

Copyright: AIB, Ghana

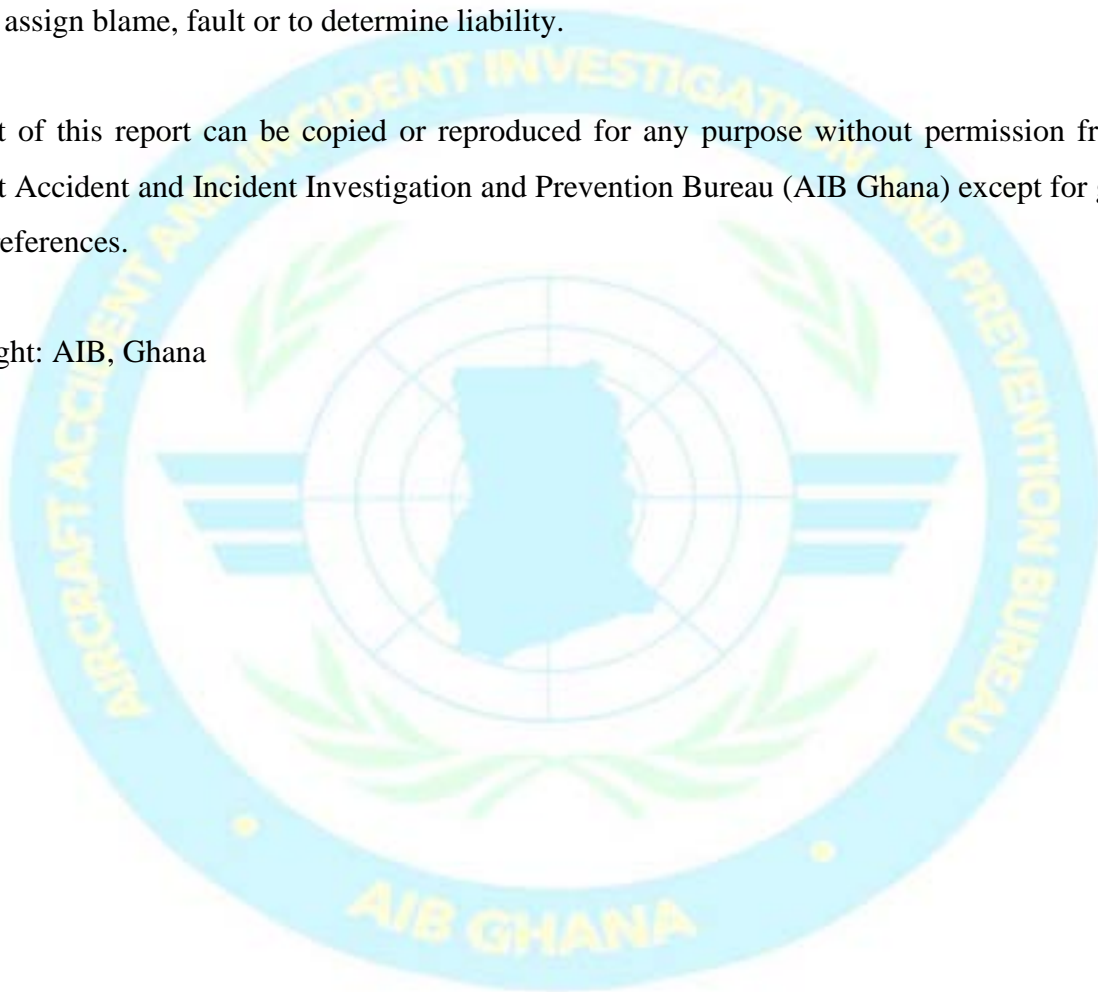

CONTENTS

LIST OF FIGURES .....	iv
GLOSSARY.....	v
DEFINITIONS.....	vi
SYNOPSIS.....	1
1 FACTUAL INFORMATION .....	3
1.1 History of the flight.....	3
1.2 Injuries to persons.....	3
1.3 Damage to aircraft.....	3
1.4 Other damage.....	4
1.5 Personnel information .....	4
1.6 Aircraft information: .....	4
1.6.1 General.....	4
1.6.2 B777-300 ER Wheels and Brakes.....	4
1.7 Meteorological information.....	6
1.8 Aids to navigation.....	6
1.9 Communications.....	6
1.10 Aerodrome information.....	6
1.11 Flight recorders.....	7
1.12 Wreckage and impact information.....	7
1.13 Medical and pathological information.....	7
1.14 Fire.....	7
1.15 Survival aspects.....	8
1.16 Tests and research.....	8
1.17 Organizational and management information.....	8
1.18 Additional information.....	8
1.19 Useful or effective investigation techniques.....	8
2 ANALYSIS.....	9
2.1 General .....	9
2.2 Flight Operations.....	9
2.2.1 Crew qualifications .....	9
2.2.2 Weather .....	9
2.2.3 Communication.....	9
2.3 Aircraft .....	10
2.3.1 Aircraft maintenance.....	10
2.4 Wildlife and Environmental Factors .....	10

---

2.4.1	Type of bird.....	10
2.4.2	Habitat.....	12
2.4.3	Season .....	12
2.4.4	Time of day .....	12
3	CONCLUSIONS.....	13
3.1	Findings.....	13
3.2	Causal and Contributing Factors .....	14
4	SAFETY RECOMMENDATIONS .....	15
	APPENDICES .....	16
	APPENDIX A: NOTIFICATION OF INCIDENT.....	16
	APPENDIX B: WHEELS WORN TO CORDS .....	20
	APPENDIX C: ILLUSTRATION OF BIRD STRIKE IMPACT AREA.....	21
	APPENDIX D: EXTRACTS FROM AIRCRAFT MAINTENANCE LOG.....	22
	APPENDIX E: KIA AERODROME INFORMATION CHART .....	26
	APPENDIX F: VALIDATED FOREIGN AIR OPERATOR CERTIFICATE.....	27
	APPENDIX G: OPERATIONAL CONDITIONS AND LIMITATIONS .....	29
	APPENDIX H: KLM OCCURRENCE REPORT .....	31

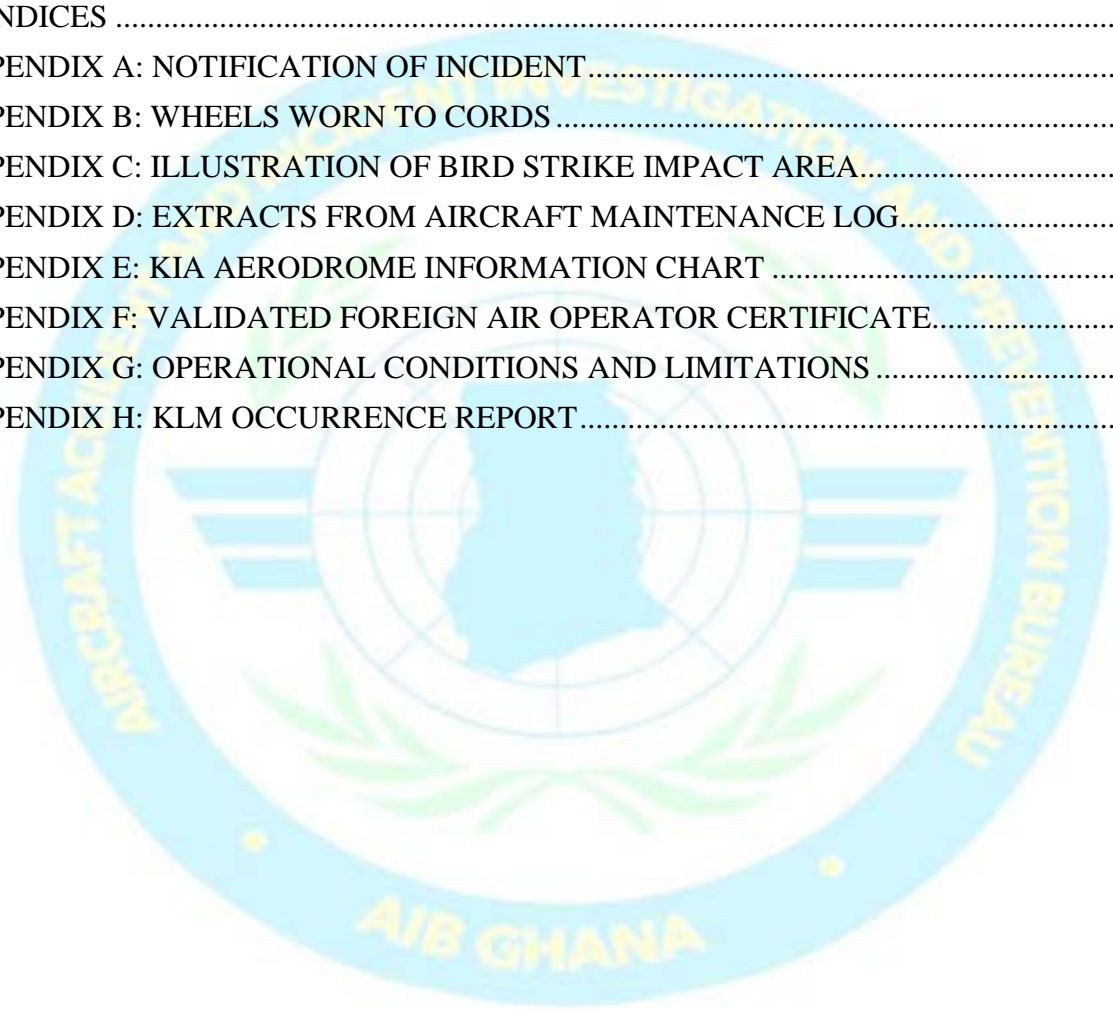

**LIST OF FIGURES**

Figure 1 B777-300 ER Brake Unit .....5  
Figure 2 B777-300 ER Wheel Numbering .....5  
Figure 3 African Wattled Lapwing .....10  
Figure 4 Wildlife Strike incidents at KIA 2016-2020.....11  
Figure 5 Bird Strike Trend at KIA- 2021.....11



GLOSSARY

AIB	-	Aircraft Accident and Incident Investigation and Prevention Bureau
AOC	-	Air Operator Certificate
ANS	-	Air Navigation Services
ATC	-	Air Traffic Control
ATS	-	Air Traffic Services
BKN	-	Broken
BWHMP	-	Bird and Wildlife Hazard Management Programme
Cavok	-	Cloud and visibility OK
ft	-	feet
GACL	-	Ghana Airport Company Limited
GCAA	-	Ghana Civil Aviation Authority
INCID	-	Incident
KIA	-	Kotoka International Airport
KLM	-	Koninklijke Luchtvaart Maatschappij (Royal Dutch Airlines)
Km	-	Kilometres
kt(s)	-	knot(s)
m	-	meters
METAR	-	Meteorological Terminal Aviation Routine weather report
mm	-	millimetres
NOSIG	-	No Significant Change
QNH	-	altimeter pressure setting to indicate elevation above mean sea level
RFFS	-	Rescue and Fire Fighting Service
RTO	-	Rejected Take-Off
SR	-	Safety Recommendation
UTC	-	Coordinated Universal Time
Z	-	Greenwich Mean Time

---

**DEFINITIONS**

**Accident.** An occurrence associated with the operation of an aircraft which, in the case of a manned aircraft, takes place between the time any person boards the aircraft with the intention of flight until such time as all such persons have disembarked, or in the case of an unmanned aircraft, takes place between the time the aircraft is ready to move with the purpose of flight until such time as it comes to rest at the end of the flight and the primary propulsion system is shut down, in which:

- a) A person is fatally or seriously injured as a result of:
- being in the aircraft, or
  - direct contact with any part of the aircraft, including parts which have become detached from the aircraft, or
  - direct exposure to jet blast,

*except* when the injuries are from natural causes, self-inflicted or inflicted by other persons, or when the injuries are to stowaways hiding outside the areas normally available to the passengers and crew; or

- b) the aircraft sustains damage or structural failure which:
- adversely affects the structural strength, performance or flight characteristics of the aircraft, and
  - would normally require major repair or replacement of the affected component,

*except* for engine failure or damage, when the damage is limited to a single engine (including its cowlings or accessories), to propellers, wing tips, antennas, probes, vanes, tires, brakes, wheels, fairings, panels, landing gear doors, windscreens, the aircraft skin (such as small dents or puncture holes), or for minor damages to main rotor blades, tail rotor blades, landing gear, and those resulting from hail or bird strike (including holes in the radome); or

- c) the aircraft is missing or is completely inaccessible.

**Incident.** An occurrence, other than an accident, associated with the operation of an aircraft which affects or could affect the safety of operation. For example, system failures (including loss of power or thrust), weather phenomena, operations outside the approved flight envelope or other occurrences which caused or could have caused difficulties controlling the aircraft.

**Investigation.** A process conducted for the purpose of accident prevention which includes the gathering and analysis of information, the drawing of conclusions, including the determination of causes and/or contributing factors and, when appropriate, the making of safety recommendations.

**Investigator-in-charge.** A person charged, on the basis of his or her qualifications, with the responsibility for the organization, conduct and control of an investigation.

## SYNOPSIS

<b>Aircraft Incident No.</b>	<b>AIB/2021/09/03/INCID</b>
Registered Owner and Operator:	KLM Royal Dutch Airlines
Manufacturer:	The Boeing Company
Aircraft Type:	B777-300 ER
Aircraft Serial Number:	42172
Registration:	PH-BVK
Place of Incident:	Kotoka International Airport (KIA), Accra, Ghana
Date:	3 <sup>rd</sup> September, 2021

### Notification

Having been made aware of an occurrence involving a KLM flight on the 3<sup>rd</sup> September, 2021 and in compliance with Annex 13 to the Convention on International Civil Aviation and the Ghana Aircraft Accident and Incident investigation and Prevention Bureau Act, 2020 (Act 1028), a team of four (4) Investigators was dispatched by the Commissioner of AIB to the site the next day, 4<sup>th</sup> September, 2021 to examine, inspect, collect data and documentation on the aircraft to enhance the investigation of the incident.

Notification of the incident was sent from the AIB Ghana to the following agencies and authorities on 6<sup>th</sup> and 7<sup>th</sup> September, 2021 that a KLM Royal Dutch Airlines Boeing 777-300 ER (Flight KL 590) from Accra to Amsterdam had executed an RTO due to a bird strike at the KIA on 3<sup>rd</sup> September, 2021 (*Appendix A*):

- The Minister of Transport, Ghana
- Ghana Civil Aviation Authority, Accra
- Ghana Airports Company Limited, Accra
- Ministry of Infrastructure and Water Management, The Hague
- The Dutch Safety Board
- Boeing Capital Corporation
- KLM Station Manager, Accra
- Accident Investigation Bureau, ICAO



On 6<sup>th</sup> September, 2021, the Commissioner appointed a four (4) member Committee to investigate the incident. Members of the Committee and their Terms of Reference are as follows:

**Committee Members**

- |                                      |   |                        |
|--------------------------------------|---|------------------------|
| 1. Air Commodore Kwame Mamphey (rtd) | - | Investigator-in-charge |
| 2. Captain Paul Forjoe               | - | Investigator           |
| 3. Ms. Philipa Acheampomaa Sarfo     | - | Investigator           |
| 4. Mrs. Rebecca Sampson              | - | Secretary              |

**Terms of Reference**

1. Establish the probable cause(s) of the incident.
2. Establish the extent of loss or damage to property.
3. Consider other relevant safety issues.
4. Make recommendations to forestall any such future occurrence.
5. Submit a final report by 8<sup>th</sup> November, 2021.

**Observers**

The Committee invited the following to join the investigation as observers.

- |   |   |                 |
|---|---|-----------------|
| 1. Captain Albert Barney Abuga          | - | Investigator    |
| 2. Captain John Yamoah                  | - | Investigator    |
| 3. Engineer Moses Nsor                  | - | Investigator    |
| 4. Wing Commander Emmanuel Akatue (rtd) | - | Investigator    |
| 5. Squadron Leader Prince Kyei-Baffour  | - | Investigator    |
| 6. Wing Commander Patrick Necku         | - | Ghana Air Force |
| 7. Squadron Leader Benjamin Yaw Appau   | - | Ghana Air Force |

The Committee commenced sitting at the AIB Conference Room on 14<sup>th</sup> September, 2021.

## 1 FACTUAL INFORMATION

### 1.1 History of the flight.

On 3<sup>rd</sup> September, 2021, at 2230 UTC KLM Flight KL590, a Boeing 777-300 ER with registration PH-BVK pushed back for its scheduled flight to Amsterdam.

The flight crew report indicates that during the take-off on Runway 03, birds were observed at about 80 knots (kts) by the crew.

At around 120 kts, the Captain observed several large birds followed by a loud impact noise. The take-off was rejected as the Captain was no longer convinced the aircraft could fly safely.

The aircraft was taxied clear of the runway and stopped. Fire department inspected the tyres. The Captain, in consultation with the KLM ground engineer had the aircraft towed to Parking Bay D1 where passengers disembarked normally at 2320UTC.

Subsequent inspection revealed that wheel numbers 3 and 11 had been deflated while wheel numbers 8 and 10 were worn to cords (*Figure 2 and Appendix B*).

Bird strike inspection was carried out. Bird remains were cleaned from underneath the Captain's number 2 Window (*Appendix C*) and no damage was found. Two dead African Wattled Lapwing birds were found on the runway during the mandatory runway inspection after the incident by GACL personnel.

High energy stop inspection was performed, axles and brakes were found to be satisfactory. Wheel numbers 3, 8, 10 and 11 were replaced followed by an independent inspection (*Appendix D*).

The aircraft was released to service on 5<sup>th</sup> September 2021.

### 1.2 Injuries to persons.

Nil

### 1.3 Damage to aircraft.

No damage

#### 1.4 Other damage.

Nil

#### 1.5 Personnel information

Not Available

#### 1.6 Aircraft information:

##### 1.6.1 General

Registered Owner and Operator:	KLM Royal Dutch Airlines
Manufacturer:	The Boeing Company
Aircraft Type:	B777-300 ER
Date of Manufacture:	2013
Aircraft Serial Number:	42172
Registration:	PH-BVK
Engine Type:	GE90-115B
Engine Manufacturer:	General Electric
Foreign Air Operators Certificate:	Valid

##### 1.6.2 B777-300 ER Wheels and Brakes

The B777-300ER has two main landing gear assemblies and a single nose gear assembly. Each main landing gear has six wheels in tandem pairs and six brake units. The nose gear is a conventional two-wheel assembly without brake units.

Three thermal release plugs in the inner half of each main gear wheel prevent tyre explosion caused by hot brakes. The plugs melt to release tyre pressure when temperature is approximately 199°C.

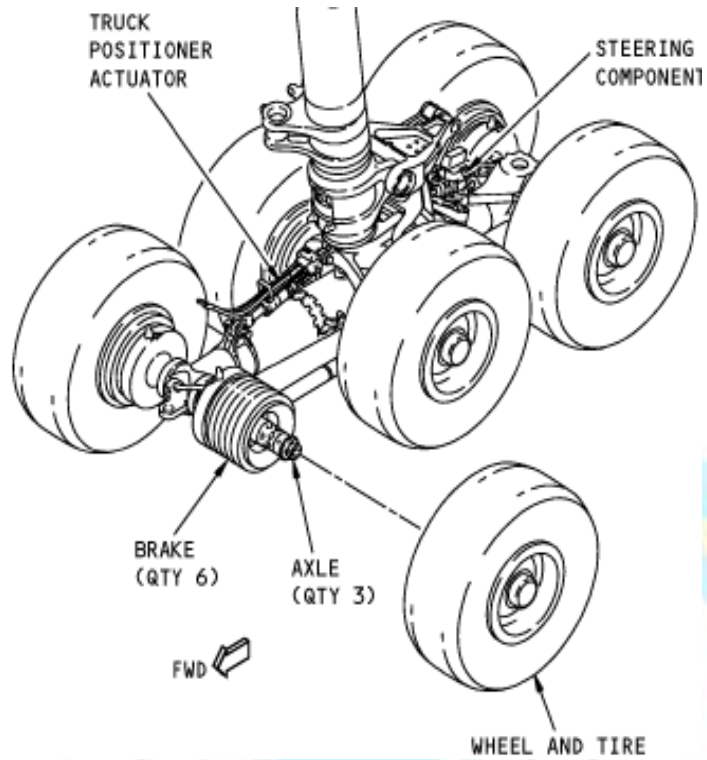

Figure 1 B777-300 ER Brake Unit

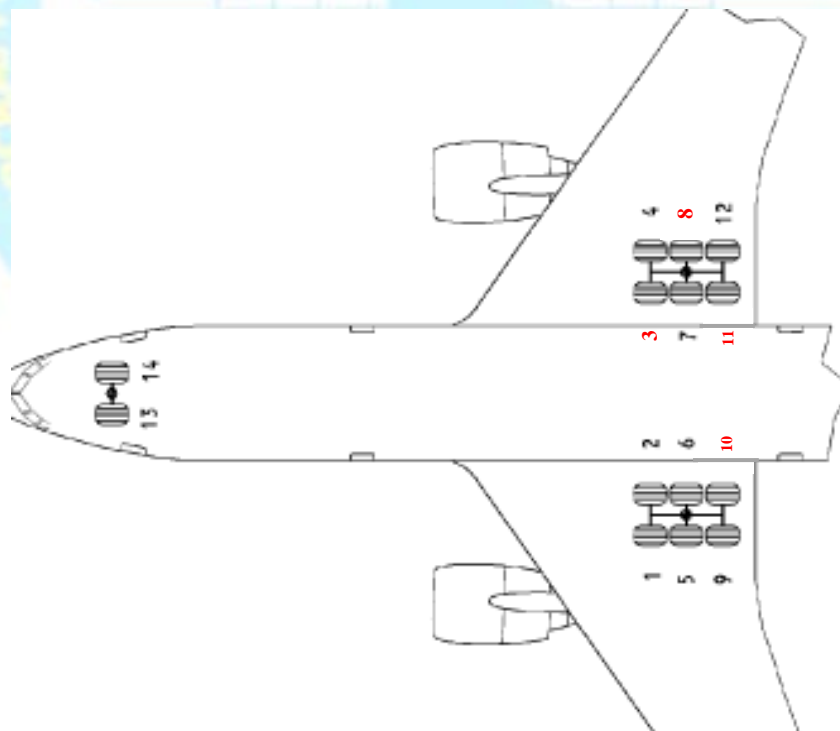

Figure 2 B777-300 ER Wheel Numbering

## 1.7 Meteorological information.

### 1.7.1 Rainfall

On the 1<sup>st</sup> September 2021, 26.00mm of rain was recorded in Accra. On the day of the occurrence, 0.1mm of rain was recorded at KIA.

### 1.7.2 METAR

The following METARs represent the routine weather report issued at KIA for the period 2230 to 2330 UTC on 3<sup>rd</sup> September, 2021.

DGAA 032230Z 24011KTS 9999 BKN011 25/24 Q1014 NOSIG

DGAA 032300Z 23010KTS 9999 BKN011 25/24 Q1014 NOSIG

DGAA 032330Z 24007KT 9999 BKN012 24/25 Q1014 NOSIG

## 1.8 Aids to navigation.

Not Applicable

## 1.9 Communications.

Communication was available and effective between the crew, ATC and Fire Service.

## 1.10 Aerodrome information.

### 1.10.1 Kotoka International Airport, Accra

Location Indicator: DGAA  
Reference Point: N 0536. 3 W 00010.1  
Elevation: 205 ft  
Runway Identification: RWY 03/21  
Runway Length: 3406m

*(Appendix E)*

### 1.10.2 Bird and Wildlife Hazard Management at KIA

The GACL has established an effective BWHM programme at all of its airports including KIA as required by GCAA Aerodrome Directives. GACL works closely with local authorities and other stakeholders in the implementation of this programme through the following:

- a. Collection, reporting and recording data on wildlife strikes and observed wildlife at its airports including KIA on a daily basis.
- b. Wildlife safety risk assessment.
- c. Habitat and land use management.
- d. Expelling or deterring wildlife presence in and around the airport.
- e. Reducing the attractiveness of identified enclaves of bird and wildlife.
- f. Quarterly meeting with all stakeholders to address wildlife hazard as required by GCAA regulations within the area of 13km radius from the airport reference point. The stakeholders are listed below:
  - i. Municipal assembly
  - ii. Environmental Protection Agency.
  - iii. Ghana Air Force.
  - iv. Airline Operators Committee.
  - v. Aviance and AHS (Ground Handlers)
  - vi. Domestic Airline Operators Committee.
  - vii. Ghana Wildlife Society.
- g. Personnel training.
- h. GACL BWHM programme is led by an ornithologist.

### 1.11 Flight recorders.

Not Applicable

### 1.12 Wreckage and impact information.

Not applicable

### 1.13 Medical and pathological information.

Not Applicable

### 1.14 Fire.

There was no evidence of fire.

**1.15 Survival aspects.**

Not Applicable

**1.16 Tests and research.**

Not Applicable

**1.17 Organizational and management information.**

KLM Royal Dutch Airlines is a holder of a validated Ghana Foreign Air Operator Certificate, No. KLM-052 issued on 22<sup>nd</sup> October, 2020 and expiring on 22<sup>nd</sup> October, 2021. This validation is dependent on the KLM Royal Dutch Airlines AOC No. NL-AOC-3/215 and associated Operations Specifications (*Appendices F and G*). The subject aircraft is approved on the Operations Specifications for use by KLM for scheduled passenger and cargo operations, as well as charter operations. KLM is also approved for Dangerous Goods operations.

**1.18 Additional information.**

Nil

**1.19 Useful or effective investigation techniques.**

Not Applicable

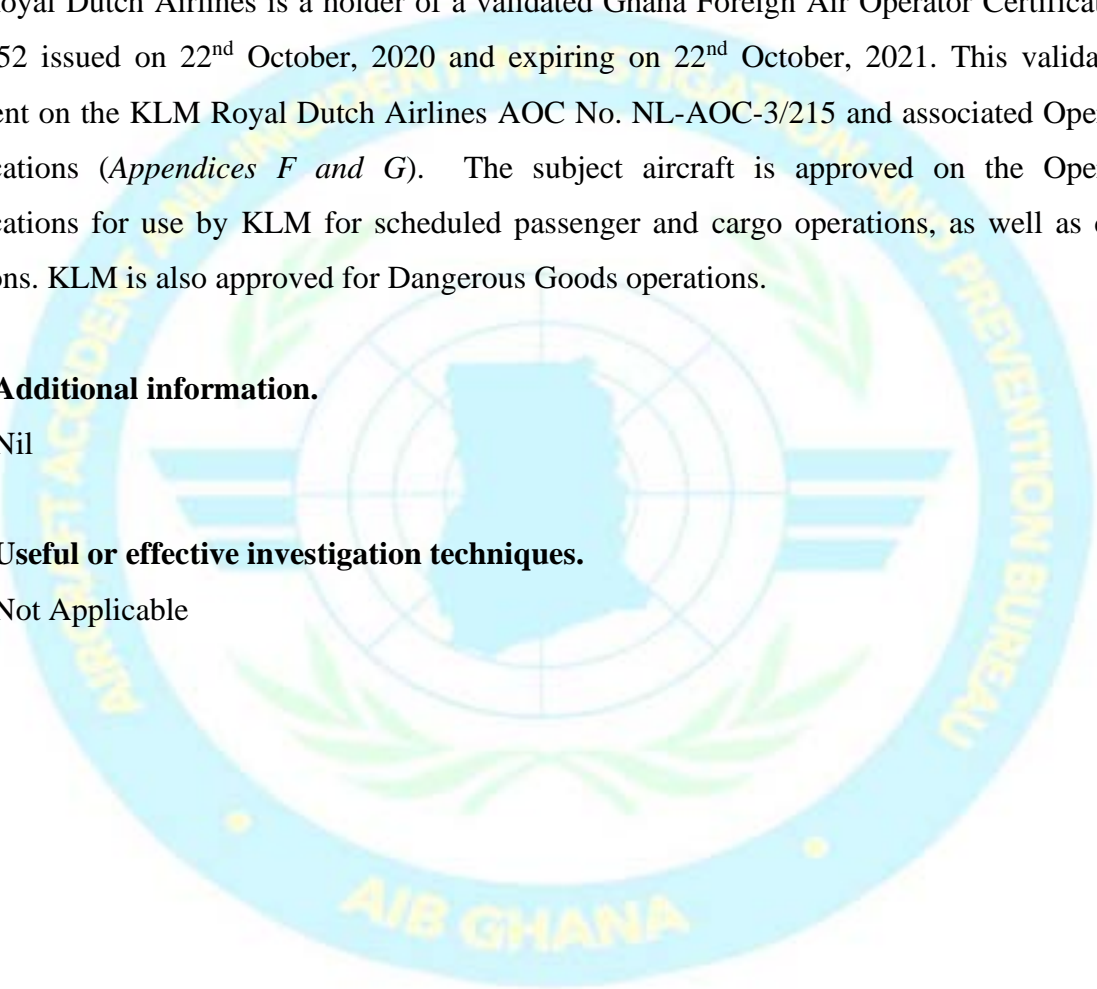

---

## 2 ANALYSIS

### 2.1 General

This analysis is based on the evidence corroborated during the course of the investigation. Contributory factors and other factors identified during the course of the investigations considered to be of importance are discussed in this section.

During the take-off roll of flight KL 590 on the 3<sup>rd</sup> of September 2021, the crew heard a loud impact noise due to a bird strike and initiated an RTO as a result of the Captain's uncertainty of the aircraft's safety for flight. "Bird remains" cleaned by the KLM Maintenance engineers from the area underneath the Captain's number 2 window is proof that the subject aircraft was struck by a bird(s).

This is confirmed by the "bird remains" picked up from the runway after the RTO and the Captain's report of the observation of birds before the incident occurred.

### 2.2 Flight Operations

#### 2.2.1 Crew qualifications

The flight crew were licensed and qualified to operate the flight. There was no correlation between the performance of the pilot and the occurrence of the bird strike.

#### 2.2.2 Weather

At the time of take-off, there was no precipitation, and visibility was in excess of 10 km. The evidence from the investigations indicates that weather at the time of the incident was not a contributory factor to the bird strike.

#### 2.2.3 Communication

Expert witnesses from ATC and GACL suggested a discrete frequency be established subject to appropriate training and protocols to facilitate direct communication between the flight crew and Fire Service in the event of an occurrence.



## 2.3 Aircraft

### 2.3.1 Aircraft maintenance

There was no evidence to suggest that the aircraft had any defect or malfunction that could have affected its performance and was not a factor in the incident. The deflated and worn-out wheels occurred as a result of the RTO. Maintenance inspection procedures carried out after the incident, indicated there was no damage to the aircraft.

## 2.4 Wildlife and Environmental Factors

The wildlife and environmental factors identified in the course of investigations are the type of bird, habitat, weather, season and time of the day.

### 2.4.1 Type of bird

It is evident that the African Wattled Lapwing (*Vanellus Senegallus*) was involved in the incident. The Lapwing is widespread in sub-Saharan Africa and commonly feeds at night. Records also indicate that the bird remains found after the incident on the runway were that of the African Wattled Lapwing. These birds are resident while breeding, but might move over distances during the rainy season.



Figure 3 African Wattled Lapwing

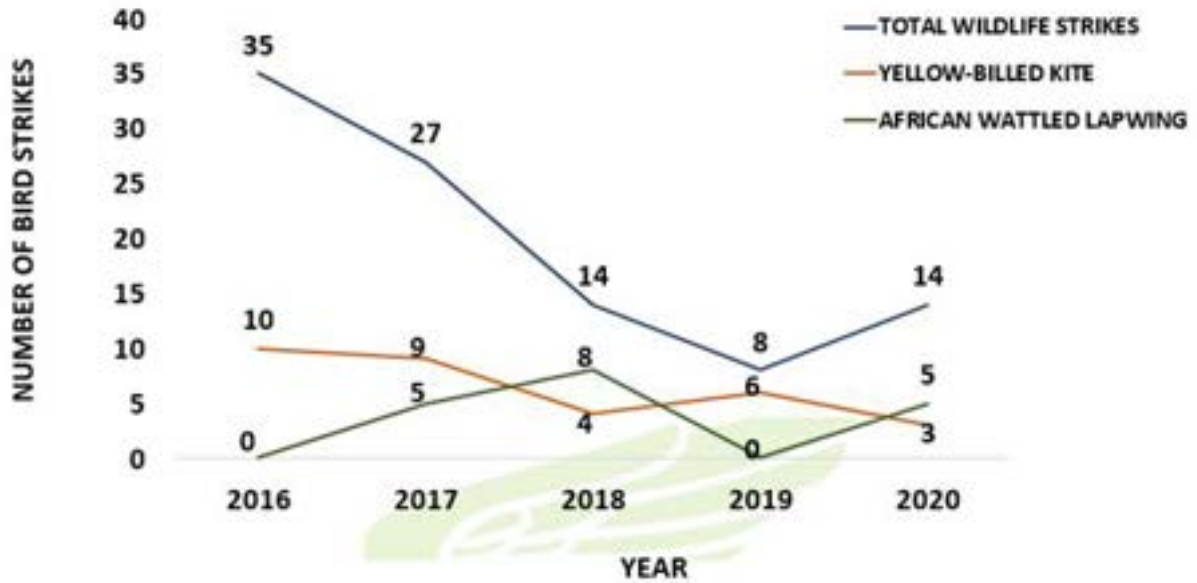

Figure 4 Wildlife Strike incidents at KIA 2016-2020

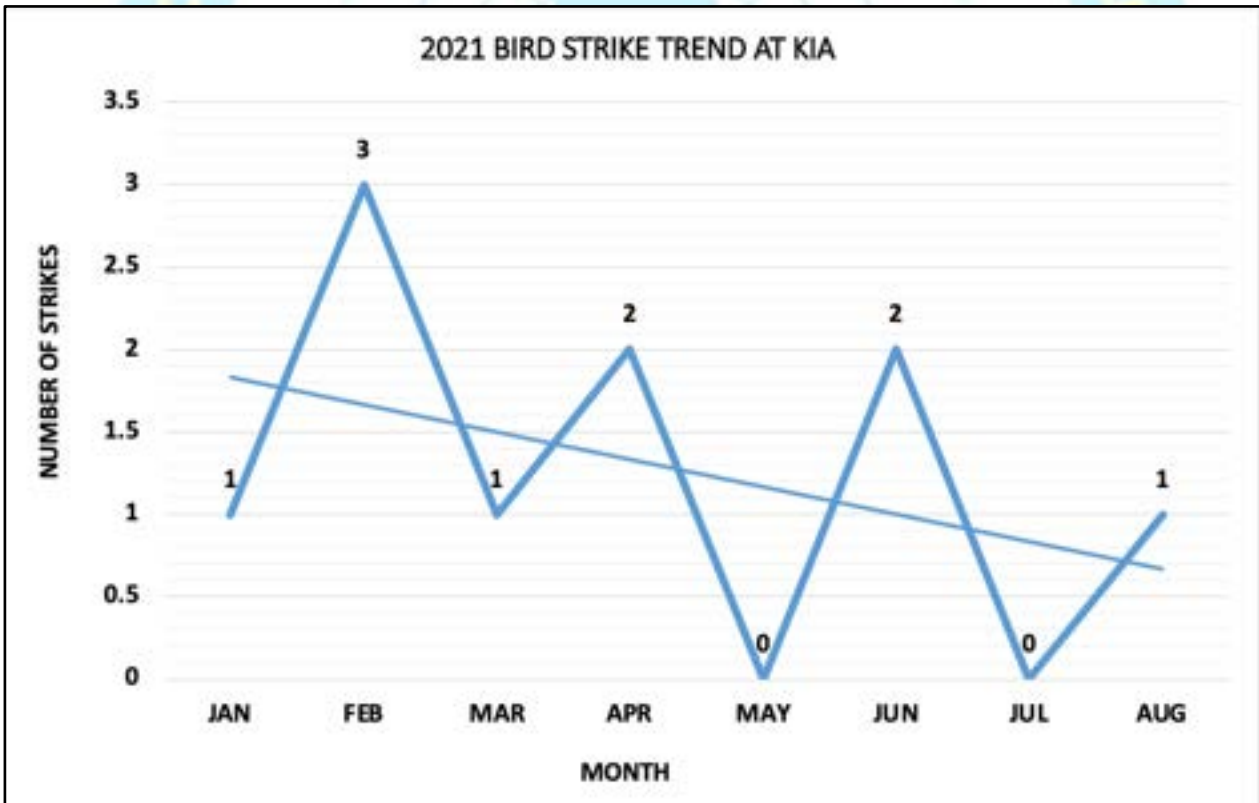

Figure 5 Bird Strike Trend at KIA - 2021

#### **2.4.2 Habitat**

The African Wattled Lapwing prefers marshes and wet grasslands. These conditions are characteristic during the rainy season in areas such as the runway shoulders. The immediate environment around the airport can contribute to the presence of the Lapwing. The diet for the African Wattled Lapwing consists almost exclusively of insects. Generally, these birds are attracted to insects which are prevalent during the rainy season.

#### **2.4.3 Season**

There are two seasons in Ghana, the dry and wet seasons. The wet season experiences rainfall in two periods; March to July and September to October. During these periods, there are large movements of ground and winged insects, displaced by the rains.

#### **2.4.4 Time of day**

Most bird strikes at KIA occur during the day. However, the Lapwing is known to feed at night and was the type of bird involved in the incident of the night of 3<sup>rd</sup> September, 2021.

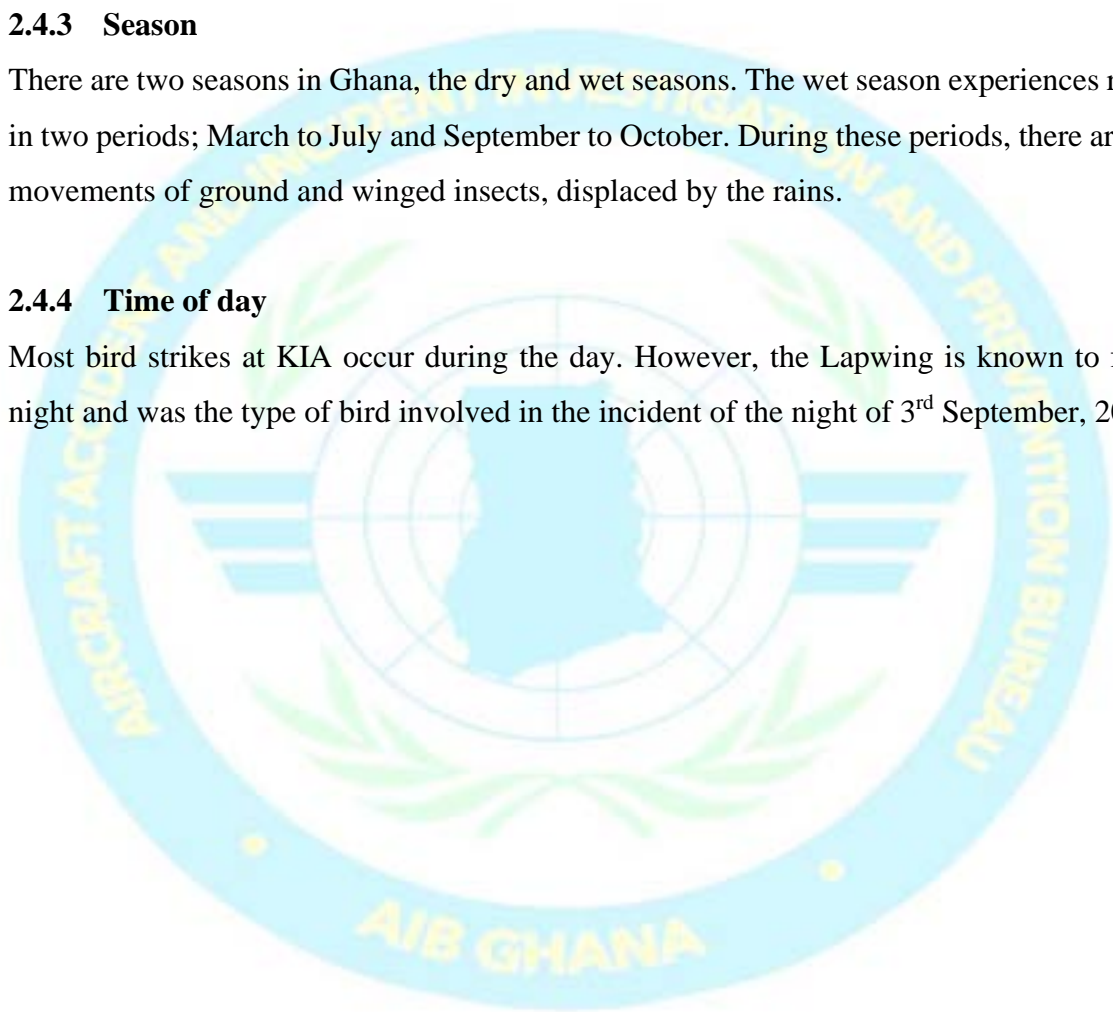

### 3 CONCLUSIONS

#### 3.1 Findings

1. The flight crew members were licensed and qualified for the flight in accordance with existing regulations.
2. The maintenance records indicated that the aircraft was equipped and maintained in accordance with existing regulations and approved procedures;
3. The aircraft was cleared for take-off on runway 03.
4. The visibility during the take-off was greater than 10 km.
5. The Captain observed several “large” birds followed by a loud impact noise at around 120 kts and initiated the RTO.
6. The loud impact noise was the result of the bird strike.
7. The RTO was initiated due to the uncertainty of the safety of the flight.
8. There was no evidence of airframe failure or system malfunction prior to the incident.
9. The aircraft was taxied clear of the runway and stopped.
10. Fire department inspected the tires, in consultation with ground engineer the aircraft was towed to Parking Bay D1.
11. Passengers disembarked normally at 2320 UTC.
12. There were no fatalities or injuries.
13. The flight crew carried out normal radio communications with ATC.
14. ATC provided prompt and effective assistance to the flight crew.
15. Wheel numbers 3 and 11 were deflated while wheel numbers 8 and 10 were worn to cords.
16. Bird remains were cleaned from underneath the Captain’s number 2 Window and no damage was found on the aircraft.
17. Two dead birds were found on the runway following a mandatory runway inspection after the incident by GACL personnel.
18. The aircraft was inspected and wheel numbers 3, 8, 10 and 11 were replaced.
19. The aircraft was released to service on 5<sup>th</sup> September 2021.
20. Bird strike occurrences may vary due to location, time of day and environmental factors.
21. GACL has an effective Bird and Wildlife Hazard Management Programme.
22. The reduction in the total bird strikes at KIA is an indication of the effectiveness of its Bird and Wildlife Hazard Management programme.

### **3.2 Causal and Contributing Factors**

The investigation identified the following causal and contributing factors.

The causal factors include:

1. The loud impact noise of the bird strike.
2. The uncertainty about the aircraft's ability to fly safely.

The contributing factors include:

1. Season.
2. The time of the flight.
3. Nocturnal feeding habits of the bird.



#### 4 SAFETY RECOMMENDATIONS

The following safety recommendations (AIB/SR/2021/01) are made:

- A. GACL should intensify coordination with stakeholders concerning Bird and Wildlife Hazard Management.
- B. GACL should increase wildlife mitigation procedures especially during the peak hours of operations.
- C. ATS/ANS should consider the establishment of a discrete frequency between flight crew and RFFS with its appropriate protocols.



APPENDICES

APPENDIX A: NOTIFICATION OF INCIDENT

*In case of reply the number and date of this letter should be quoted.*

My Ref. No. AIB/2021/09/03/INCID

Your Ref. No. \_\_\_\_\_



AIRCRAFT ACCIDENT AND INCIDENT INVESTIGATION AND PREVENTION BUREAU

TEL: +233 29 901 5633  
+233 29 901 5632  
+233 29 901 5636

Date: 7<sup>th</sup> September, 2021

ACTING DIRECTOR GENERAL  
CIVIL AVIATION AUTHORITY  
MINISTRY OF INFRASTRUCTURE AND  
WATER MANAGEMENT  
RIJNSTRAAT 8  
P.O BOX 20901  
2500 EX THE HAGUE

ATTN: [aviation-approvals@ilent.nl](mailto:aviation-approvals@ilent.nl)

Dear Sir/Madam,

**NOTIFICATION OF AIRCRAFT INCIDENT**

Please find below details about the Civil Aircraft Incident which occurred soon after commencement of take-off roll at the Kotoka International AirPort (KIA) in the Republic of Ghana.

a)	Occurrence Type	INCID
b)	manufacturer, model, nationality and registration marks, and serial number of the aircraft	BOEING, 777-300ER, Netherlands, PH-BVK, 42172; LN:1106
c)	name of owner, operator and hirer, if any, of the aircraft;	KLM ROYAL DUTCH AIRLINES
d)	name, qualification of the pilot-in-command and nationality	VAN HILTEN MARC PHILIP, NETHERLANDS (DUTCH),BOEING LICENCE
e)	date and time (local time or UTC) of the accident or incident	3rd September 2021 at 22:35 (Local Time)
f)	last point of departure and point of intended landing of the aircraft	Kotoka International Airport / Amsterdam Airport Schiphol

La Wireless, Adjacent AU Village  
Cantonments-Accra  
GPS: QL-025-7031

P. O. Box KA 10412  
Greater Accra - KIA Post Office

[aib@caa.gov.gh](mailto:aib@caa.gov.gh)

[www.caa.gov.gh](http://www.caa.gov.gh)

g)	position of the aircraft with reference to some easily defined geographical point and latitude and longitude	Upon take-off RWY 21 Kotoka International Airport
h)	number of crew and passengers; aboard, killed and seriously injured; others, killed and seriously injured	13 crew members 355 Passengers +2 infants  All passengers were disembarked with no casualties.
i)	description of the accident or incident and the extent of damage to the aircraft so far as is known	Aircraft was accelerating for takeoff from RWY 03 when the crew rejected takeoff at high speed about 145knots (overground) due to a bird strike 22:35 local time close to windshield. Captain had to apply emergency brakes (high brakes). 2 tyres deflated and two other tyres got worn out. No fire, only hot brakes. The aircraft slowed safely, vacated the RWY at the end and became disabled at the parallel taxiway. The Aircraft was towed back to ramp (d1) at 23:21 Local Time after becoming disabled on the taxiway.
j)	an indication to what extent the investigation will be conducted or is proposed to be delegated by the State of Occurrence.	Minor-scaled Investigation to be conducted by the Aircraft Accident and Incident Investigation and Prevention Bureau of Ghana.
k)	physical characteristics of the accident or incident area, as well as an indication of access difficulties or special requirements to reach the site	Clear weather condition.
l)	identification of the originating authority and means to contact the investigator-in-charge and the accident investigation authority of the State of Occurrence at any time	Ghana Civil Aviation Authority Private Mail Bag Kotoka International Airport Accra, Ghana Mr. Daniel Acquah Deputy Director-General (Technical) +233 20 222 4051



		<p>e-mail: <a href="mailto:dacquah@caa.com.gh">dacquah@caa.com.gh</a></p> <p>Investigator-in-Charge: Air Cdre. Kwame Mamphey +233 24 435 5444 <a href="mailto:Kwame.mamphey@aibghana.gov.gh">Kwame.mamphey@aibghana.gov.gh</a></p> <p>The Commissioner Aircraft Accident and Incident Investigation and Prevention Bureau P.O. KA 16412 Kotoka International Airport +233 27 100 0888 <a href="mailto:info@aibghana.gov.gh">info@aibghana.gov.gh</a></p>
m)	presence and description of dangerous goods on board the aircraft	No dangerous goods on board



AKWASI A. PREMPEH  
AG. COMMISSIONER

CC:

The Secretary Director  
Dutch Safety Board  
P.O. Box 95404  
2509 CK The Hague  
Netherlands  
Email: [aviation@safetyboard.nl](mailto:aviation@safetyboard.nl)

Boeing Capital Corporation  
P. O Box 3707  
Seattle Washington 98124  
Email: [bcc@west.boeing.com](mailto:bcc@west.boeing.com)

The Accident Investigation Bureau  
999 University Street, Montreal Quebec  
Canada H3C 5H7  
Fax: + 1(514) 954-6077  
TEL: + (514) 954-8219  
Email: [AIGinbox@icao.int](mailto:AIGinbox@icao.int)

Victor Onoja  
Joint Station Manager  
Klm Ghana  
[victor-onoja@klm.com](mailto:victor-onoja@klm.com)

The Honourable Minister  
Ministry of Transport  
Ministries-Accra

APPENDIX B: WHEELS WORN TO CORDS



APPENDIX C: ILLUSTRATION OF BIRD STRIKE IMPACT AREA

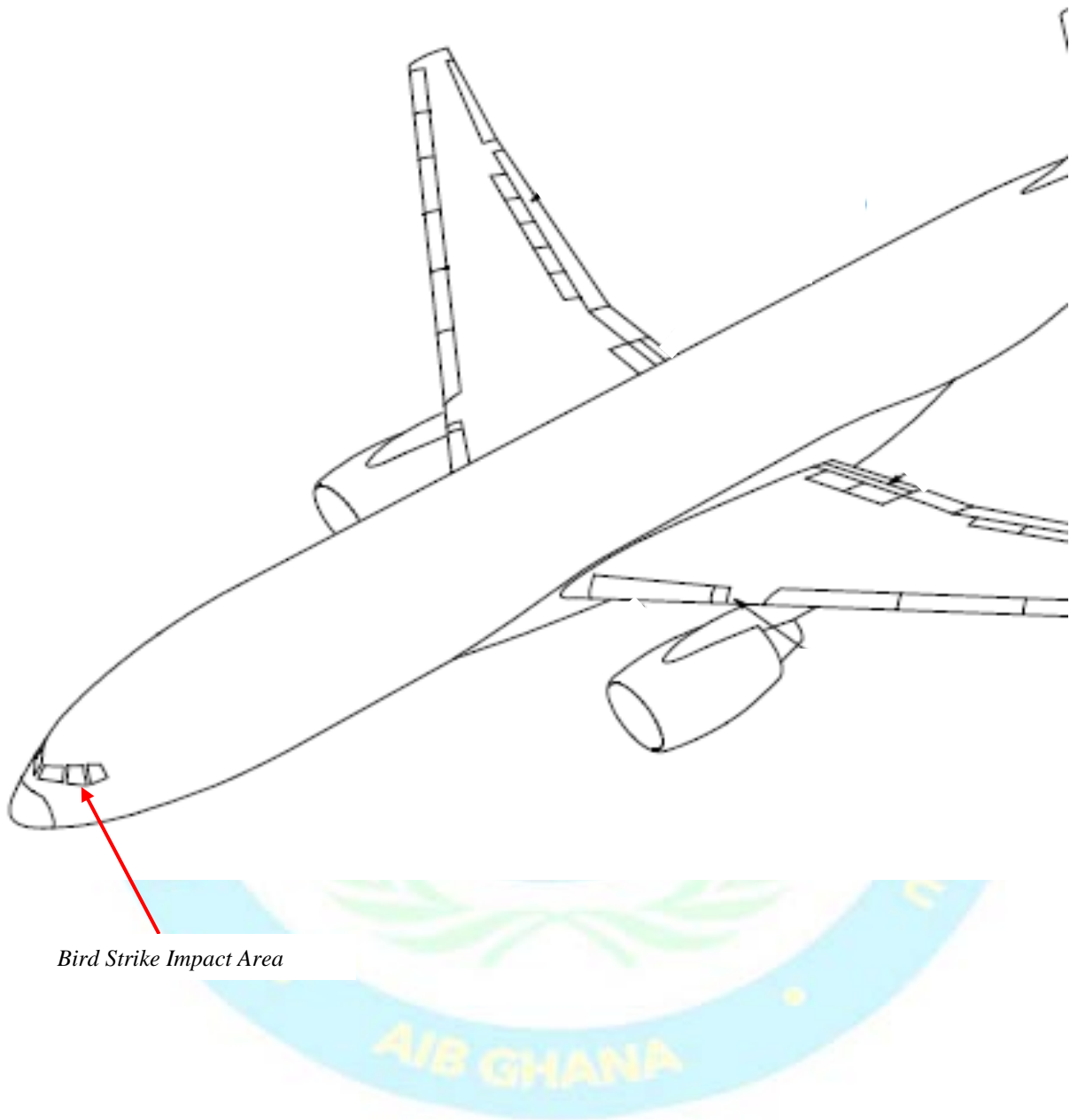

APPENDIX D: EXTRACTS FROM AIRCRAFT MAINTENANCE LOG



**KLM AIRCRAFT MAINTENANCE LOG PAGE**



LOG NO. 11120135

SECOND-GOLDEN COPY	Flight no <b>S90</b>	Dep. stn <b>ALL</b>	A/C Reg <b>PH-BVK</b>	A/C Type <b>030221</b>	D D M M Y Y <b>030221</b>	Part no	Serial no	Form no
	Fault name: <b>TRES</b>				ATA <b>0551</b>			
	Description: <b>T/O ABORTED AT APPR 120LTS 2 TIRES FUSES BLOWN</b>				(Connective) Action: <b>Man Energy Sop Insp. Check 1A2 NAM 05-51-14-210-801 - 2 Tire INTERNAL Fuses Blown (#3 &amp; #11 Wires) Found Wires # 8 &amp; #9 Also Damaged (Fused). Also Inspect Buses Found Serviceable.</b>			
					Refer MEL / CDL item no.		MEL Interval Cat: <input type="checkbox"/> A <input type="checkbox"/> B <input type="checkbox"/> C <input type="checkbox"/> D	
	FRM code		PRR1-145.A.50 release to service by: <b>KLM</b>		NO: <b>11120135</b>		Ref. Stn. D D M M UTC <b>A/C 0409 0620</b>	

---



**KLM AIRCRAFT MAINTENANCE LOG PAGE**



LOG NO. 11120136

SECOND-GOLDEN COPY	Flight no <b>514</b>	Dep. stn <b>ACC</b>	A/C Reg <b>PH-BVK</b>	A/C Type <b>773040921</b>	D D M M Y Y <b>030221</b>	Part no	Serial no	Form no
	Fault name:				ATA <b>3200</b>			
	Description: <b>5x L/G Pins Inspected</b>				(Connective) Action: <b>5x Ground Pins Removed &amp; Shown In Test Deck</b>			
					FRM code		PRR1-145.A.50 release to service by: <b>KLM</b>	

22  
CONFIDENTIAL

**KLM AIRCRAFT MAINTENANCE LOG PAGE** LOG NO. 11120137

Flight no.	Dep. stn.	A/C Reg.	A/C Type	D	D	M	M	Y	Y	Part no.	Serial no.	Form no.
570	Acc	PH-BVK	773	0	4	0	9	2	1			
Fault name:										ATA 05.00		
Description:										(Corrective) Action:		
Due Bird Strike Under CAPT. #2 Window T/O. No. 11120137										Bird Strike Under Capt #2 Window. Remaining Cleared From Underneath CAPT #2 Window. No Damage Found.		
Relief MEL / CCL item no.										MEL Interval		
										Cat. A B C D		
Or E1 E2 E3 E4 ETOPS										MEL Procedure		
NE 120 180										(N) 100 175		
Act. Stn. D D M M UTC										Name Sign Auth. no.		
FRM code										PWR-145.A.50 release to service by: KLM		
Rel. Stn. D D M M UTC										PH-BVK 11120137		
Acc 040906												

**KLM AIRCRAFT MAINTENANCE LOG PAGE** LOG NO. 11120138

Flight no.	Dep. stn.	A/C Reg.	A/C Type	D	D	M	M	Y	Y	Part no.	Serial no.	Form no.
570	Acc	PH-BVK	773	0	4	0	9	2	1	3-148	2130	
Fault name:										ATA 3200		
Description:										(Corrective) Action:		
Wheels #3, #8, #10 & #11 To Be Checked Due Damage From High Energy Stop.										WHEEL #3 & WHEEL #11 REPAIRS IAW PWR TASK 32-45-01 Due Thermal Fuse Blow. Spacers Installed. SATIS. For Identification Use See 11120140		
Relief MEL / CCL item no.										MEL Interval		
										Cat. A B C D		
Or E1 E2 E3 E4 ETOPS										MEL Procedure		
NE 120 180										(N) 100 175		
Act. Stn. D D M M UTC										Name Sign Auth. no.		
FRM code										PWR-145.A.50 release to service by: KLM		
Rel. Stn. D D M M UTC										PH-BVK 11120138		
Acc 040922												

**KLM AIRCRAFT MAINTENANCE LOG PAGE** LOG NO. 11120139

Flight no: 570 Acc PH-BVK TT3040921 Part no: 3-166 Serial no: 2017 Form no: 1305  
ATA 3200

Fault name: Riv. No. # 1120138

Description: Wheel #3 HS HN & H11 To Be Checked Due Damage From Heat Energy STOP.

(Corrective) Action: Wheel #8 & H11 Replaced IAW Appr Inspr 32-45-01 Due Rolling Beyond Limit. Spacers Installed Satisfies For Independent Insp See 1120141

Refer MEL / CDL item no. MEL Interval Cat: A B C D

CD E1 E2 E3 E4 ETDPS MEL Procedure  
AE 120 100 (M) (O) (I)

Act Stn: D D M M UTC Name: Sign: Auth: no.

PART-145.A.30 release to service by: KLM no: 111, 145, 13

Ret Stn: D D M M UTC  
ACC 0409 2328

NAME: Crew Tech

FORM code

FORM 1112-07-18

**KLM AIRCRAFT MAINTENANCE LOG PAGE** LOG NO. 11120140

Flight no: 570 Acc PH-BVK TT3040921 Part no: Serial no: Form no:  
ATA 3200

Fault name:

Description: Riv 1120138 Wheel #13 & H11 Replaced. Independent Insp. Performed Maint. Performed. Appendix C

(Corrective) Action: INDEPENDENT INSPECTION PERFORMED AS PER LPMC S.I.500 REV 15 AND ACCIDENTAL AMM TASK 32-45-01 REV 92

Refer MEL / CDL item no. MEL Interval Cat: A B C D

CD E1 E2 E3 E4 ETDPS MEL Procedure  
AE 120 100 (M) (O) (I)

Act Stn: D D M M UTC Name: Sign: Auth: no.

PART-145.A.30 release to service by: KLM no: NL1115, 1115

Ret Stn: D D M M UTC  
ACC 0409 2350

NAME: FORM code

FORM 1112-07-18

**KLM** AIRCRAFT MAINTENANCE LOG PAGE



LOG NO. 11120141

SECOND - GOLDEN COPY

Flight no	Dep. str	A/C Reg	A/C type	D	D	M	M	Y	Y	Part no	Serial no	Form no
570	ACC	PH-BVK	7730	4	0	9	2	1				
Fault name:				ATA 3200		in		out				
Description:				(Corrective) Action:								
P/L 11120139 WHEEL # 8 & #10 <sup>th</sup> REPLACED. INDEPENDENT INSP REQ'D AS PER MAINT PROG APPENDIX C				INDEPENDENT INSPECTION PERFORMED AS PER LPMC S.I. 500 REV 15 AND ACCORDING AMM TASK 32-45-01 REV 92.								
Relief MEL / CDL item no						MEL interval						
						Cat. A <input type="checkbox"/> B <input type="checkbox"/> C <input type="checkbox"/> D <input type="checkbox"/>						
Oil	E1	E2	E3	E4	ETOPS			MEL Procedure				
refill					NE <input type="checkbox"/> 120 <input type="checkbox"/> 180 <input type="checkbox"/>			(M) <input type="checkbox"/> (O) <input type="checkbox"/> (T) <input type="checkbox"/>				
Act. Str	D	D	M	M	UTC		Name	Sign	Auth no			
FRM code				PART-145.A.50 release to service by: KLM no. NL-145-1113								
				Rel Str		D	D	M	M	UTC		
				ACC		0	4	0	9	23 <sup>55</sup>		

KLM 4337-07 16



APPENDIX E: KIA AERODROME INFORMATION CHART

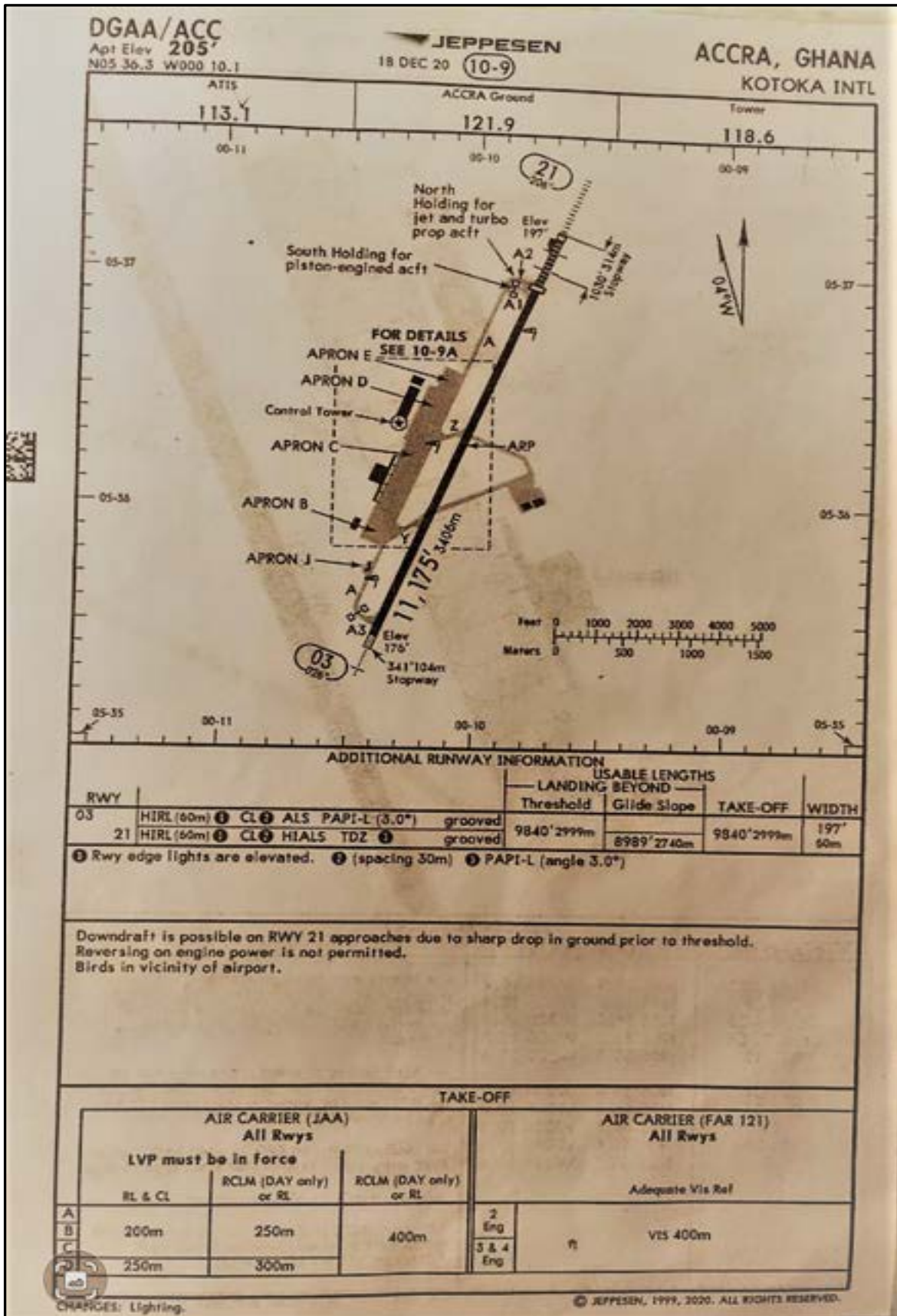

## APPENDIX F: VALIDATED FOREIGN AIR OPERATOR CERTIFICATE

*Ghana Civil Aviation Authority*



Our Ref: AIR/4133/062/28  
Your Ref:  
Dig. Add: GL-135-7178

22<sup>nd</sup> October, 2020

The Accountable Manager  
Klm Royal Dutch Airlines  
Amsterdamsseweg 55  
1182 Gp Amstelveen  
The Netherlands

Dear Sir,

**RENEWAL OF VALIDATED FOREIGN AIR OPERATOR CERTIFICATE NO. KLM-052**

Please find attached the original copy of the above-mentioned certificate.

The Approval is valid from 23<sup>rd</sup> October, 2020 to 22<sup>nd</sup> October, 2021 unless revoked, suspended or varied.

Please be guided accordingly.

Yours faithfully,

  
ING. CHARLES KRAIKUE  
DIRECTOR-GENERAL

cc: HON. MINISTER OF AVIATION

THE CHIEF OF AIR STAFF  
GHANA AIR FORCE, HEADQUARTERS  
BURMA CAMP – ACCRA

MANAGING DIRECTOR  
GHANA AIRPORTS COMPANY LTD  
ACCRA

DEPUTY DIRECTOR-GENERAL (F/A)  
AG. DEPUTY DIRECTOR-GENERAL (T)  
DIRECTOR, SAFETY REGULATION  
DIRECTOR, LEGAL SERVICES  
DIRECTOR, ECONOMIC REGULATIONS & BUSINESS DEVT

Private Mail Bag  
Kotoka International Airport  
Accra, Ghana

Tel: (233)-(30) 2776171  
Fax: (233)-(30) 2773293  
E-mail: info@gcaa.com.gh

Site: ACCOTYF  
AFTN: DGAAIYYX  
Website: www.gcaa.com.gh

Safety & Security, Our Priority



**VALIDATION OF FOREIGN AIR OPERATOR CERTIFICATE**

**Ghana**

**Validation of Foreign Air Operator Certificate**

**VAOC Number: KLM - 052** **ISSUE Number: 2020-001**

This is to certify that

**KONINKLIJKE LUCHTVAART MAATSCHAPPIJ N.V. (ROYAL DUTCH AIRLINES)**

Conforms to the requirements of Ghana Civil Aviation (Flight Standards) Directives Part 10 and is authorized to conduct commercial air transport operations into or from Ghana territory in accordance with the Air Operator Certificate and associated Operations Specifications issued by the CIVIL AVIATION AUTHORITY THE NETHERLANDS and the Conditions and Limitations specified in this Validation of Foreign Air Operator Certificate.

This Validation Certificate is issued on the basis of the CIVIL AVIATION AUTHORITY THE NETHERLANDS Air Operator Certificate number NL-AOC-3/215, and remains in force from the date of issue as long as the aforementioned Air Operator Certificate remains valid. Any changes to the original AOC or related condition or limitations must be notified in writing to the Authority within 30 days of such a change.

Unless otherwise stated in the attached Conditions and Limitations the approvals and restrictions of the Air Operator Certificate and associated Operations Specifications remain valid within Ghana, in so far as they are not repugnant to the Civil Aviation Directives of Ghana.

This Validation, may be cancelled, suspended, or revoked by the Director-General at any time if the conditions of the issue are infringed by the Foreign Air Operator or if the Director-General determines that such action is required in the interests of aviation safety.

Effective Date: **23<sup>rd</sup> OCTOBER, 2020** Date of Expiry: **22<sup>nd</sup> OCTOBER, 2021**

Signature:  **Issue Date: 22<sup>nd</sup> OCTOBER, 2020**

**Director-General, GCAA**



APPENDIX G: OPERATIONAL CONDITIONS AND LIMITATIONS



**CONDITIONS AND LIMITATIONS FOR OPERATIONS INTO, WITHIN, OR FROM GHANA TERRITORY**

1. Company registered name as stated in the Validation certificate:  
**KONINKLIJKE LUCHTVAART MAATSCHAPPIJ N.V. (ROYAL DUTCH AIRLINES)**

2. Address of Principal Place of Business

2.1 Mailing address: <b>AMSTERDAMSEWEG 55 1182 GP AMSTELVEEN THE NETHERLANDS</b>	2.2 Telephone numbers: <b>+31 20 64 93456</b>
	2.2 Fax number: <b>N/A</b>
	2.4 E-mail: <b>IRAP@klm.com</b>

3. Trading name(s) if different than the Registered name stated on the Authorization, under which the Operator may operate:  
**KONINKLIJKE LUCHTVAART MAATSCHAPPIJ N.V. (ROYAL DUTCH AIRLINES)**

4. The types of operations authorized:

	Scheduled Operations	Charter Operations	Other
Passenger and Cargo	<input checked="" type="checkbox"/>	<input checked="" type="checkbox"/>	<input type="checkbox"/>
Cargo only	<input type="checkbox"/>	<input type="checkbox"/>	<input type="checkbox"/>
Dangerous Goods	<input checked="" type="checkbox"/>	<input checked="" type="checkbox"/>	<input type="checkbox"/>

5. Conditions and limitations (if required)  
**SUBJECT TO THE PROVISIONS OF KONINKLIJKE LUCHTVAART MAATSCHAPPIJ N.V. (ROYAL DUTCH AIRLINES) AIR OPERATOR CERTIFICATE No. NL-AOC-3/215 AND ASSOCIATED OPERATIONS SPECIFICATIONS AND THE REQUIREMENTS OF THE GHANA CIVIL AVIATION (FLIGHT STANDARDS) DIRECTIVES**  
**[THIS CERTIFICATE MUST ALWAYS BE ATTACHED TO KONINKLIJKE LUCHTVAART MAATSCHAPPIJ N.V. (ROYAL DUTCH AIRLINES) AOC & OPSPECS FOR ALL OPERATIONS INTO DGAA].**



Signature & Stamp:  Issue Date: **22<sup>nd</sup> OCTOBER, 2020**  
Issue Number: **2020-001**



**6. Destination airports in Ghana to be served:**  
**KOTOKA INTERNATIONAL AIRPORT, ACCRA**

**7. Aircraft types authorized for use:**  
**B777-200**  
**B777-300**  
**B787-9**  
**B787-10**  
**A330-200**  
**A330-300**

**8. Frequency of flights:**  
**AS PER AGREEMENT**

**Signature & Stamp:**  

**Issue Date: 22<sup>nd</sup> OCTOBER, 2020**  
**Issue Number: 2020-001**

APPENDIX H: KLM OCCURRENCE REPORT



## KLM Engineering & Maintenance

---

### OCCURRENCE REPORTING LMI

---

**General**

Date : 03 Sep 2021

Reported by

Name or "confidential" : [REDACTED]

E-mail address : [REDACTED] Only required if you wish personal feedback on this occurrence

Station : ACC

Reported via manager : [REDACTED]

Registered by DMM (OCC) : [REDACTED] DMM (Duty Maintenance Manager)

Information via : E-mail

**Aircraft / Engine Identification**

Aircraft type : B777-200/300

Engine type : GE-90

Registration : PH-BVK e.g. PH-BFA or engine serialnumber

Operator : KL e.g. KL, NW

**Flight Identification**

Flight number : KL590 e.g. AMS-YYG

Location / stretch : RUNWAY

Phase : Takeoff Consequence : Abort

**Occurrence description**

Description / Remarks

TAKE OFF ABORTED AT APPROX 120KTS AFTER BIRDSTRIKE UNDER CAPT #2 WINDOW. THERMAL FUSES BLOWN ON WHEELS 3 AND 11. THREAD PEELED ON WHEELS 8 AND 10. A/C TOWED TO GATE AT 2320 GMT

---

Ref. AML/CML : 11120135 ATA-chapter : 05, 32

Component name : WHEEL

Partnumber : 3-1618 AND 3-1666 Serial number : 4290,2110,1308,0465

Action and /or Remarks

BIRD REMAINS CLEANED AND BIRD STRIKE INSP PERF PER AMM TASK 05-51-18-210-801. NIL FURTHER DAMAGE FOUND. HIGH ENERGY STOP INSPECTION DONE PER AMM 05-51-14-210-801. AXLES AND BRAKES FOUND SATIS. WHEELS 3,11, 8 AND 10 REPLACED PER AMM TASK 32-45-01. INDEPENDENT INSPECTIONS PERF PER LPM 5.1.500. A/C SERVICEABLE AT 0010GMT 05 SEP 21. A/C DEPART AT 0145GMT 05 SEP 21.

**Send by e-mail** When "send by email" button does not work automatically or any other parts of this form on your system, please send an email with attached completed form to: [bvair@klm.com](mailto:bvair@klm.com)

Note: please make sure that rotables or other aircraft parts that are suspect under this occurrence are isolated, tagged with PIT (Parts Investigation Tag) and quarantained, all according to LPM-C 5.2.600.

---

KLM E&M 10651-06.16